

# **Safari**

## *Instruction Manual*





# Quick Start

- 1 Turn on Safari by pressing the Power button.
- 2 On initial start-up, your detector will default to the factory Coin Mode.
- 3 To select a different factory preset Detect Mode, press and release the appropriate Mode button.
- 4 The  icon next to the corresponding preset Detect Mode, indicates that a factory preset Mode has been selected. The detector will apply the factory determined Discrimination Pattern and audio response for that Mode.
- 5 Press the Noise Cancel button and wait the 20 seconds it takes to select the most stable channel.
- 6 Once the Noise Cancel sequence is completed you can start detecting!

Minelab is always interested in your opinions. If you have any questions or comments regarding the Safari or any other Minelab product, please feel free to contact us directly or via your local Authorised Minelab dealer.

For further product information and detecting tips, refer to:

**[WWW.MINELAB.COM](http://WWW.MINELAB.COM)**



## Congratulations on purchasing your Minelab



Thank you for purchasing the Minelab Safari metal detector.

Metal detecting is a fascinating and rewarding activity enjoyed by people all over the world. By getting to know your Safari you can become one of the many successful detectorists who combine their passion for the outdoors with the excitement of discovering valuable coins, relics, gold and jewellery on a regular basis.

Safari will locate valuable metal objects such as gold, coins, jewellery and other metallic items. The detector's easy-to-use control panel enables anyone, from beginner to expert, to start detecting immediately after assembly.

Minelab recommends you initially use Safari in one of the four selectable factory preset modes to become familiar with its operation. These Detect Modes have been optimised to provide you with settings suitable for most applications.

Your Safari is designed to provide you with years of treasure hunting enjoyment. To ensure you get the most from your Safari, we recommend that you read this Instruction Manual to help assemble, take care of and learn how to operate your new detector.

Minelab wishes you every success with your Safari!



# Contents

Inside Front Cover	<a href="#"><b>Quick Start</b></a>
3	<a href="#"><b>How Metal Detectors Work</b></a>
4	<a href="#"><b>The Technology of Safari</b></a>
5	<a href="#"><b>Assembly</b></a>
8	<a href="#"><b>Adjusting the Detector for Comfortable Detecting</b></a>
10	<a href="#"><b>Battery Packs</b></a>
13	<a href="#"><b>Turning the Detector On</b></a>
14	<a href="#"><b>Introducing the Control Panel</b></a>
16	<a href="#"><b>Introducing the Detect Screen</b></a>
18	<a href="#"><b>Detecting Basics</b></a>
19	<a href="#"><u>A Simple Detecting Exercise</u></a>
21	<a href="#"><b>Detect Modes</b></a>
22	<a href="#"><u>Coin Mode</u></a>
22	<a href="#"><u>Coin &amp; Jewellery Mode</u></a>
23	<a href="#"><u>Relic Mode</u></a>
23	<a href="#"><u>All Metal Mode</u></a>
24	<a href="#"><b>Pinpoint</b></a>
25	<a href="#"><b>Menu</b></a>
26	<a href="#"><u>Sensitivity</u></a>
26	<a href="#"><u>Target Volume</u></a>
27	<a href="#"><u>Threshold</u></a>
27	<a href="#"><u>Noise Cancel</u></a>
28	<a href="#"><u>Contrast</u></a>
28	<a href="#"><u>Trash Density</u></a>
30	<a href="#"><b>Discrimination</b></a>
30	<a href="#"><u>Discrimination (Accept/Reject) Scale</u></a>
30	<a href="#"><u>To Modify the Discrimination Pattern</u></a>
32	<a href="#"><u>To Create and Save a User Mode</u></a>
33	<a href="#"><b>Technical Specifications</b></a>
34	<a href="#"><u>Factory Presets</u></a>
	<a href="#"><b>User Information</b></a>
35	<a href="#"><u>Recovering the Target</u></a>
36	<a href="#"><u>Treasure Locations</u></a>
37	<a href="#"><u>Detector Care and Safety</u></a>
38	<a href="#"><u>Troubleshooting</u></a>
39	<a href="#"><u>Warranty and Accessories</u></a>
40	<a href="#"><u>Service and Repair Form</u></a>

Metal detectors create an electromagnetic (EM) field around the coil, which penetrates the ground. Because metal is conductive it causes a change in this field. The detector senses this change through the coil and sends a signal back to the control box, alerting the operator.

Metal detectors can determine the size, shape and composition of metallic objects beneath the coil. Typically, the larger the object, the easier it is to detect.

A metal detector's EM operating frequencies are measured in kilohertz (kHz). Low frequency EM fields (e.g. 1.5kHz) penetrate the ground deeply, but sensitivity to smaller targets is low. High frequency EM fields (e.g. 65kHz) have a shallower depth of penetration, but sensitivity to small targets is high.

Safari's multiple frequency operation provides the advantage of both; good depth and high sensitivity.

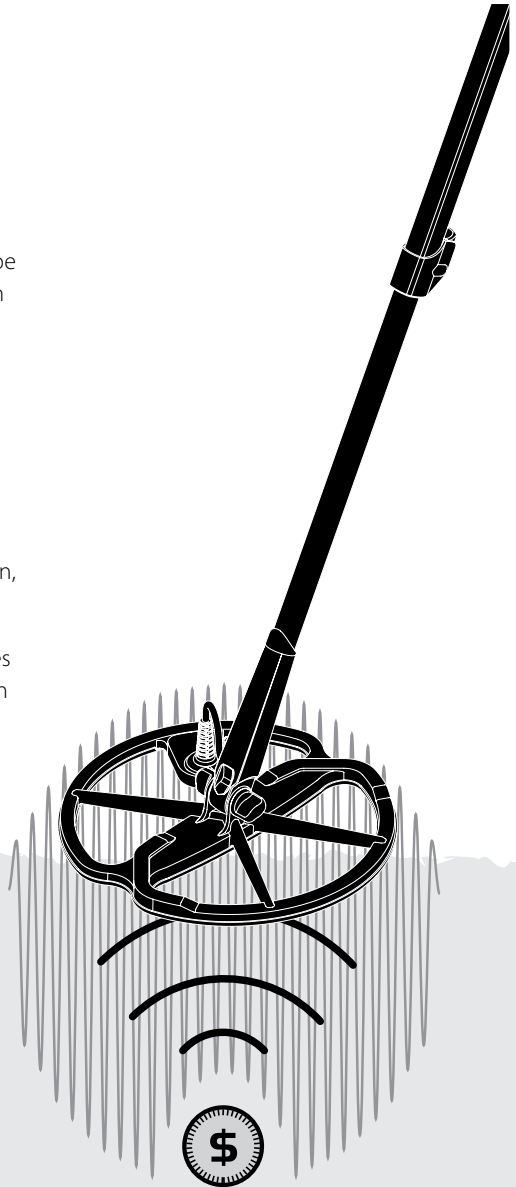



# The Technology of Safari

## Full Band Spectrum (FBS)

Most detectors on the market operate on a single or dual frequency, ranging from 1 to 70 kilohertz (kHz).

Although this technology has served the industry well for years, Minelab found that a frequency that worked well in one area would often offer only marginal performance when used in another location. Ground mineralisation, trash content and target size all had an impact on how effectively a detector transmitting a single frequency would operate.

FBS technology combines Minelab's multiple frequency BBS (Broad Band Spectrum) technology with a powerful new microprocessor to give:

- Greater detecting depth
- High sensitivity over a wide range of targets
- Less interference from electromagnetic sources
- More accurate identification of target characteristics

The FBS circuit automatically transmits multiple frequencies simultaneously. This increased frequency range means that the signal received from the detector coil is analysed from a wide range of responses. This allows Safari to analyse more target information so that the target identification (ID) is more accurate.

Minelab's unique FBS technology means deep, sensitive, accurate detecting.

## Discrimination (Disc.)

Discrimination is the ability of a metal detector to identify your desired targets (e.g. coins and jewellery) and eliminate signals from undesirable material (e.g. nails).

Safari can be programmed in a number of ways to discriminate against unwanted targets in different types of ground.

## Ground Compensation

Safari uses a sophisticated approach for the elimination of ground mineralisation effects. It uses advanced digital filtering to eliminate the influence of ground signals. This is achieved automatically, allowing you to concentrate on detecting targets.

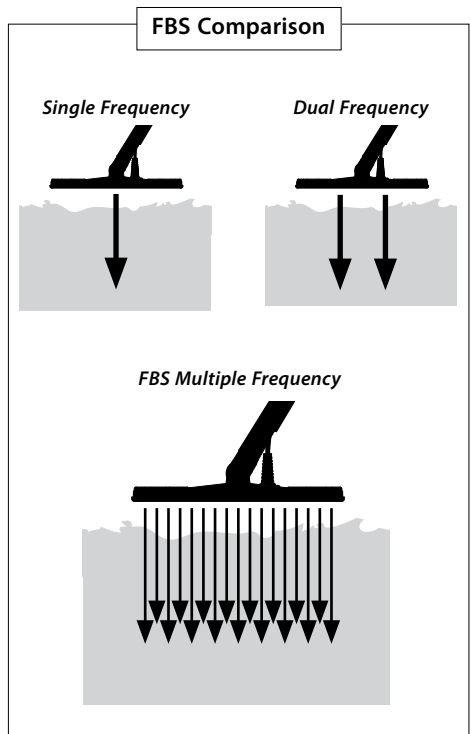

## Attaching the coil to the Lower Shaft:

**Note:** Before attaching the coil to the Lower Shaft, remove the nut, bolt and washers from the coil.

- 1 Plug the two rubber washers into the holes on either side of the Lower Shaft.
- 2 Feed the coil cable up through the inside of the Lower Shaft, ensuring the coil cable appears out the top of the Lower Shaft.

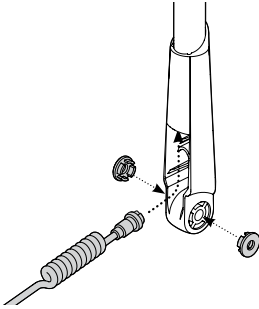

- 3 Place the coil on a flat surface.
- 4 Slide the Lower Shaft into the bracket on top of the coil. Ensure that the open side of the Lower Shaft faces the ground.

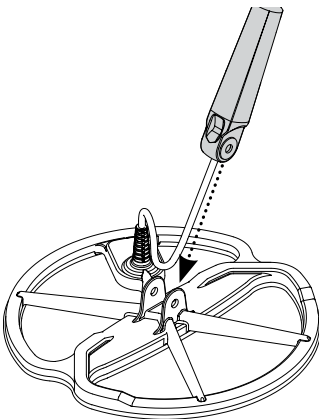

- 5 Insert the bolt through the Lower Shaft and the bracket on top of the coil.
- 6 Fasten with the nut provided, taking care not to damage the thread of the nut by over-tightening. This will need to be loosened later to adjust the coil to a comfortable detecting angle.

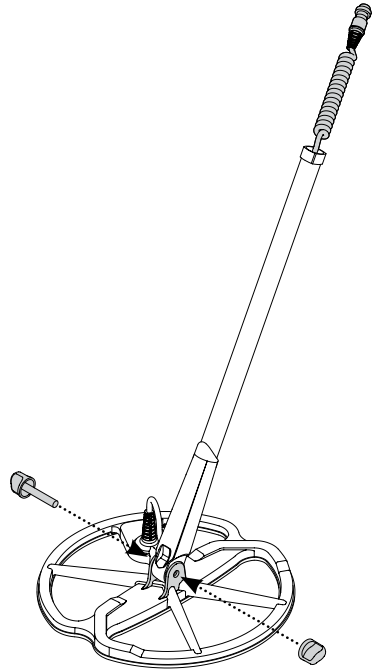

**WARNING:** The coil cable is directly wired into the coil and is not removable. Any attempt to remove this cable will void your warranty.

## Attaching the Lower Shaft to the Upper Shaft:

- 1 Release the Upper Shaft camlock by pulling the lever away from the shaft.
- 2 Feed the coil cable up through the inside of the Upper Shaft, ensuring the camlock side of the shaft is facing the ground.

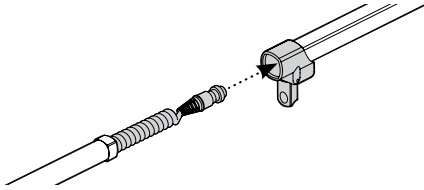

- 3 Slide the Upper Shaft over the Lower Shaft, so the coil cable appears out the top.

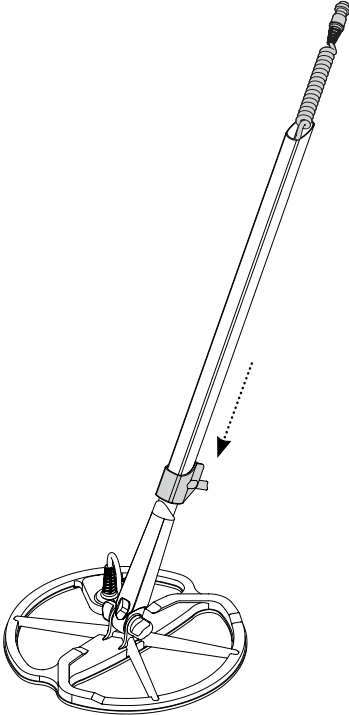

## Connecting the Shaft Assembly to the Handle Assembly:

- 1 Release the Control Box camlock by pulling the lever away from the Control Box.
- 2 Align and push the coil cable connector into the socket underneath the Control Box, firmly tightening the retaining ring to secure.

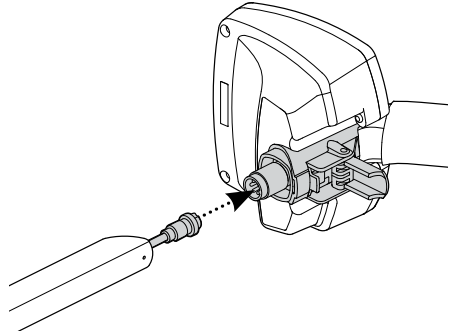

- 3 Push the Handle Assembly onto the Upper Shaft, as far as it will go.
- 4 Lock the Control Box camlock by pushing the lever flat onto the Control Box.

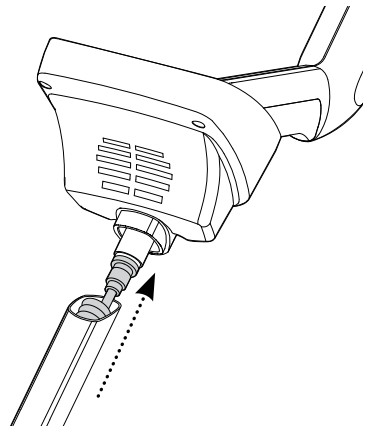



### Attaching the Armrest Strap:

- 1 Clip both buckles onto the outer sides of the armrest.

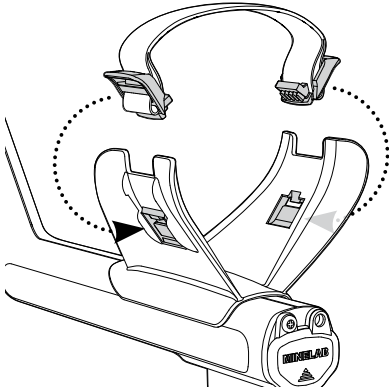

### Attaching the Headphones:

- 1 Plug the headphone jack into the headphone socket, located in the rubber seal at the battery end of the Handle Assembly.

The headphones may be plugged or unplugged at any time.

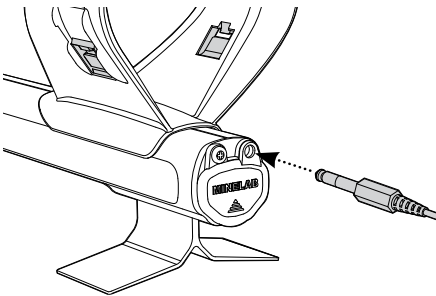

### Disconnecting the coil:

- 1 Reverse the steps in 'Connecting the Shaft Assembly to the Handle Assembly', 'Attaching the Lower Shaft to the Upper Shaft' and 'Attaching the coil to the Lower Shaft'.
- 2 Pull the coil cable out from inside the lower shaft.

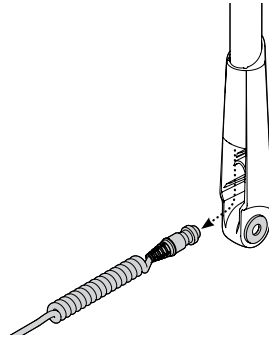

**WARNING:** Do not attempt to completely remove the shaft assembly while the coil cable is still connected to the Control Box.



# Adjusting the Detector for Comfortable Detecting

For comfortable detecting it is important to take the time to adjust the detector correctly.

## Holding the Detector

Thread your arm through the armrest and strap. Grasp the handle of the detector and rest your forearm in the armrest.

The correct position of the armrest should allow you to comfortably grip the handle. Your elbow should sit just above the back of the armrest and the detector should feel like an extension of your forearm.

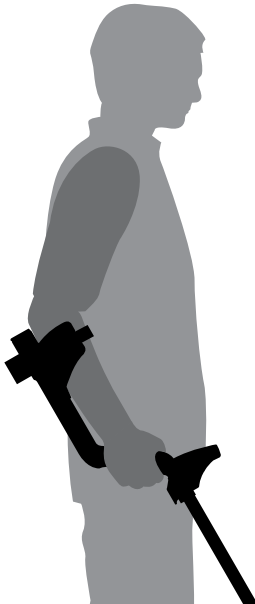

## Adjusting the Armrest Strap:

- 1 Loosen the strap by tilting the top edge of the buckle out to release it from the armrest.
- 2 Undo the Velcro and pull the buckle outwards (towards yourself) to loosen the strap.
- 3 Clip the buckle back into place and tighten the strap until your arm is secure whilst in the armrest. Re-attach the Velcro.

## Adjusting the Position of the Armrest:

- 1 Use a screwdriver, or the edge of a coin, to loosen the screw in the centre of the armrest (turn counter-clockwise).

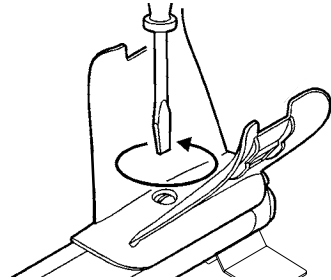

- 2 While holding the detector, slide the armrest to sit just below your elbow.
- 3 Remove your arm. Tighten screw (turn clockwise) to lock the armrest into position.

## Adjusting the Length of the Shafts

A correct shaft length will allow you to swing the coil over the ground without uncomfortably stretching or stooping.

If the coil is too far from your body it will be difficult to balance and manoeuvre while detecting.



**X** *Shaft is too short*

If the coil is too close to your body it may detect your digging tools or any other metal which you are carrying, causing confusing sounds.

Adjust the lower shaft to the correct length, securing the camlock to hold it in place.

A longer lower shaft is available for tall people (p. 39).



**✓** *Shaft is the correct length*

## Adjusting the Angle of the Coil:

- 1 Loosen the bolt that connects the Lower Shaft to the Coil. It should be loose enough to allow the Coil to be moved for adjustment, but tight enough that the Coil can hold its position.
- 2 While holding the detector as if detecting, lightly press the Coil to the ground until it sits flat/parallel with the ground. The Coil should remain parallel when lifting to the sweep height, approximately 25mm (1") above the ground.
- 3 Tighten the bolt, but do not over-tighten it.

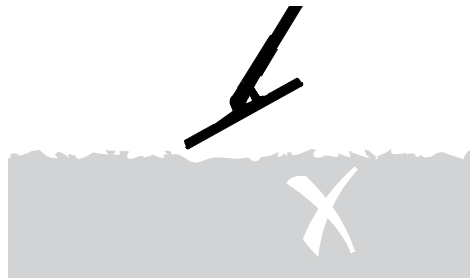
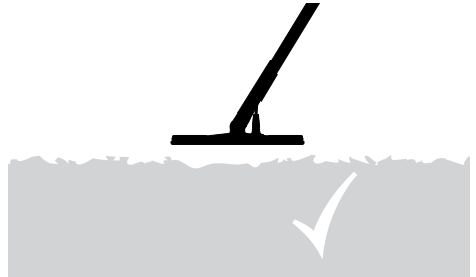
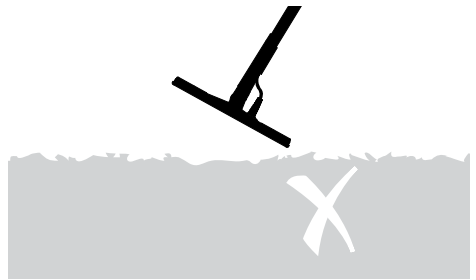



# Battery Packs

Safari comes with a standard Alkaline battery pack. Eight high quality, fresh, 1.5V AA alkaline batteries will power the Safari for up to 14 hours of constant use.

Optional accessory NiMH battery packs are available as well (See Accessories p. 39). The NiMH 1600 mAh battery pack will power the detector for up to 12.5 hours of constant use and the NiMH 1800 mAh battery pack for 14 hours.

Unlike Nickel Cadmium batteries, the NiMH battery pack DOES NOT have to be discharged before recharging. Whenever the detector has been unused for a lengthy period, recharge the battery pack to ensure full performance. There is no limit to the time the battery pack can be left on charge.

**Note:** Removal instructions apply to both types of battery packs.

## Removing the Battery Pack from the Battery Compartment:

- 1 Ensure that the detector is turned off before removing the battery pack.
- 2 Rest the detector on a flat surface. Disconnect the headphones.
- 3 Lift the rubber seal of the battery compartment located at the end of the handle assembly.
- 4 Raise the yellow tab to release the spring loaded battery pack.

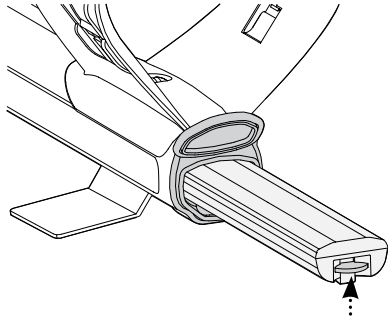

- 5 Remove the battery pack entirely from the battery compartment.

## Inserting the Battery Pack into the Battery Compartment:

- 1 Lift the rubber seal of the handle assembly.
- 2 Slide the battery pack entirely into the handle assembly, until it clicks into place.
- 3 Close the rubber seal, to close the battery compartment.



**WARNING:** Do not attempt to disassemble the NiMH battery pack.

If disposing of battery pack, do not incinerate. Contact your local authorities to enquire about disposal or recycling facilities.

### Replacing 'AA' Batteries:

- 1 Slide the lid of the battery pack in the direction of the arrow to open.
- 2 Place eight high quality AA cell alkaline batteries into the battery pack, ensuring that the + and – terminals are aligned as indicated on the label.

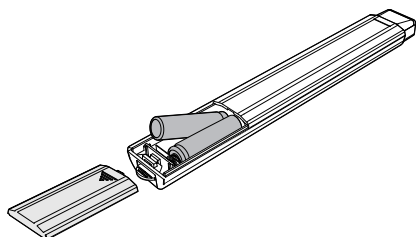

- 3 Slide the battery pack lid closed until it 'clicks' into place.

High quality alkaline batteries are recommended for optimum detection time. Rechargeable alkaline, NiMH or NiCad AA batteries may be used but must be removed and recharged separately. Check fitment of rechargeable batteries prior to purchase, as some do not comply with standard size requirements.



### WARNING – Please note the following:

- Do not use rechargeable Lithium Ion batteries with your Safari. They may damage the detector and void your warranty. Rechargeable Lithium Ion batteries will give a combined voltage above 13V and therefore cannot be used with Safari.
- Do not leave drained AA batteries in the detector as they can leak.
- The optional rechargeable battery packs will not be damaged if left on the charger for more than 22 hours.
- The battery chargers will not recharge rechargeable alkaline or NiCad AA batteries.
- Using a non-Minelab charger with the battery pack may damage it and will void the product warranty.
- Unlike Nickel Cadmium batteries, the NiMH battery pack DOES NOT need to be drained of all power before being recharged.
- Do not charge the battery at temperatures above 45°C (113°F).
- Do not charge the battery at temperatures below 0°C (32°F).
- Do not leave the battery exposed to very hot conditions (e.g. on the dashboard or rear parcel shelf of your car) or very cold conditions.



## Charging the 1600/1800mAh NiMH Battery Packs (optional accessories)

To charge your battery, only use the Minelab charger designed for your NiMH battery. Using other chargers may damage your battery and will void the product warranty.

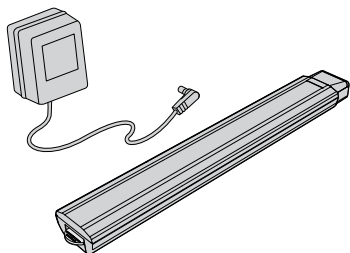

### Recharging NiMH Battery Packs with the Mains Charger:

- 1 Remove the battery pack.
- 2 Insert the mains charger cable into the socket at the tapered end of the battery pack.
- 3 Plug the mains charger into the wall socket and turn on the switch.
- 4 Leave for 18 hours to fully recharge the 1600mAh pack (22 hours for the 1800mAh pack). If the battery was not completely discharged, the charging time will be shorter. New batteries will reach their full capacity after several charge/discharge cycles.
- 5 Once charged, disconnect the battery charger plug from the battery pack.

**Note:** It is normal for the tip of the rechargeable battery to get warm while charging.

### Recharging NiMH Battery Pack with the Car Charger:

- 1 Remove the battery pack.
- 2 Insert the car charger plug into the accessories socket of your vehicle.
- 3 Insert the car charger plug into the socket at the tapered end of the battery pack.  
  
A small light on the car charger illuminates indicating that the car charger is in operation.
- 4 Leave for 18 hours to fully recharge the 1600mAh pack (22 hours for the 1800mAh pack). If the battery was not completely discharged, the charging time will be shorter.
- 5 Some vehicles may require the ignition to be switched on to 'Accessories' for power to be supplied to the charger.
- 6 Charging the battery for longer than 18 hours will not damage the NiMH battery pack. However, it may gradually discharge your car battery.

**Note:** The car charger is provided with a fuse for short circuit protection. This can be accessed by unscrewing the tip of the charger plug.

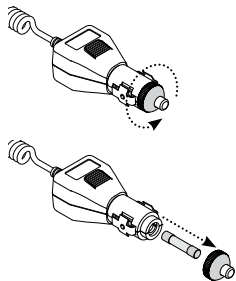



## To Turn on Safari:

Press and release the Power button to turn your detector on/off. On first time start-up, your detector will default to the Coin Mode and you can begin detecting.

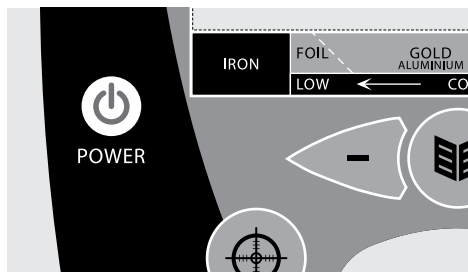

When you turn your detector on, the detector will start with the last setting used in your previous detecting session.

## Quick Start

- Turn on Safari by pressing the Power button.
- On initial start-up, your detector will default to the factory Coin Mode.
- To select a different factory preset Detect Mode, press and release the appropriate Mode button.
- The  icon next to the corresponding preset Detect Mode, indicates that a factory preset Mode has been selected. The detector will apply the factory determined Discrimination Pattern and audio response for that Mode.
- Press the Noise Cancel button and wait the 20 seconds it takes to select the most stable channel.
- Once the Noise Cancel (p. 27) sequence is completed you can start detecting!



**Important:** While performing a Noise Cancel it is important to keep the detector's coil motionless, and also ensure that no metallic objects are moved in close proximity to the detector's coil.



# Introducing the Control Panel

## Coin

Pressing activates the Coin Detect Mode (p. 22).

## Coin & Jewellery

Pressing activates the Coin & Jewellery Detect Mode (p. 22).

## Power

Pressing turns Safari On/Off.  
Holding for approx. five seconds resets the detector (p. 34) to the Factory Preset settings, prior to startup.

## Pinpoint

Pressing turns Pinpoint On/Off . Pinpoint (p. 24) assists in locating the exact position of a target prior to recovery.

## Minus & Plus (-/+)

Pressing in the Menu will step through the settings.  
Pressing within a Menu setting will adjust that setting (p. 25).

## Menu

Used to access the Menu at any stage of detector operation. This allows access to various settings (p. 25).

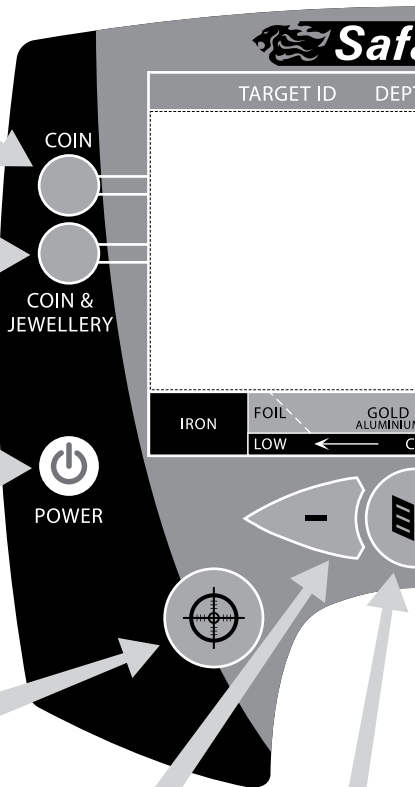



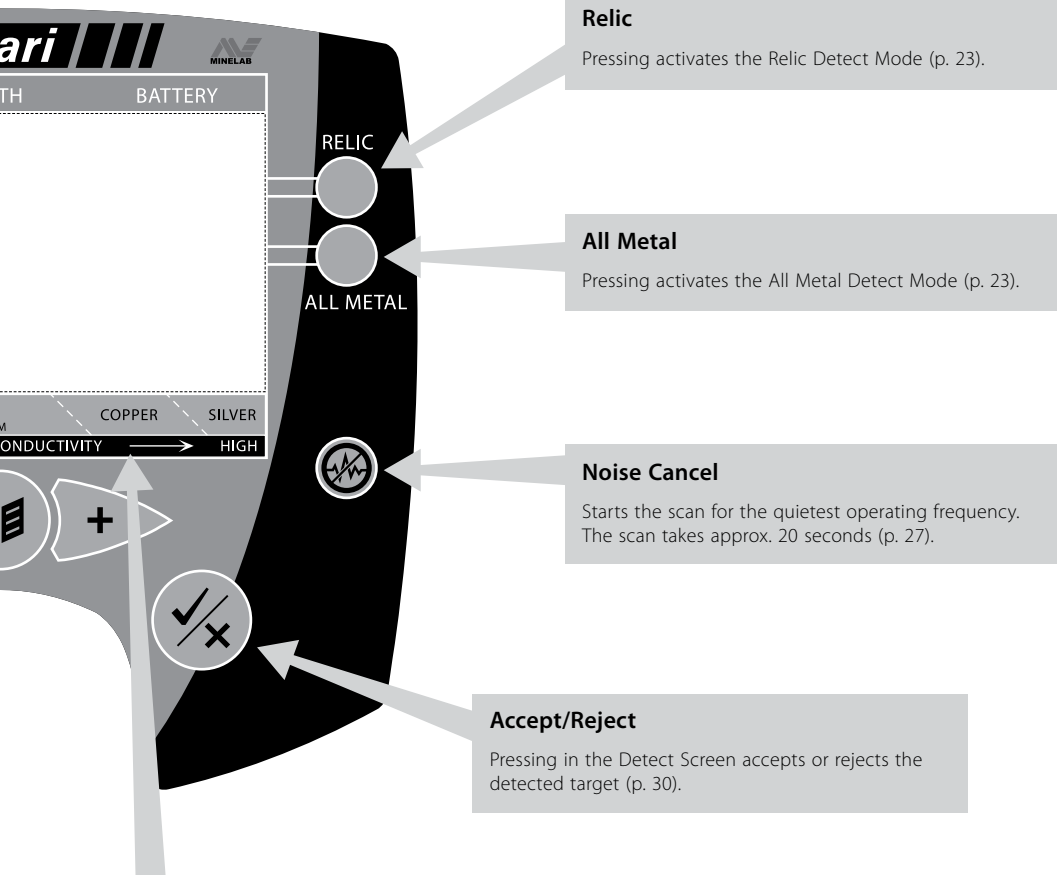

## Legend Scale

When a target is detected it is categorized based on the types of metal objects that typically produce a similar kind of signal. This is represented by the "flashing" icon in the Graphic Identification Bar. The Legend Scale is designed to be a useful guide to the "probable" composition of a target based on the detected signal. The accuracy of this representation is dependent on certain factors such as: ground type, target conductivity, the angle of the target in the ground, its depth, age and physical condition.

**Note:** In some instances this can result in similar target objects appearing in different areas of the Graphic Identification Bar, which is not unusual. For example, the metal content of older pennies compared to new pennies can vary greatly and aluminium objects such as pull tabs (ring-pulls) may also display similar characteristics. The broken lines on the Legend Scale, between typical target types, represent the potential for overlap.

As you gain experience with your Safari you will become more familiar with the audio and visual clues that the detector will provide.



## Depth Gauge

Located in the centre of the Detection Screen is a vertical bar which predicts the likely depth of the target.

On shallow targets the cursor is very close to the top and the bar becomes almost fully shaded, whereas for deep targets the cursor is quite close to the bottom and the bar is only partially filled.

## Target ID Number

When a target is detected while searching, a number appears on the left side of the Detect Screen identifying the characteristics of the target.



ID numbers ranging from -10 through to +40 are Safari's numerical identification of the type of target that has been located. Different target types will bring up different numbers.

**Note:** You can use these same ID numbers to make alterations to the Discrimination Pattern (p. 30) and they will also be useful for recognising common targets.

## Mode Indicator

This  icon, next to the corresponding preset Detect Mode, indicates that a factory preset Mode has been selected. The detector will apply the factory determined Discrimination Pattern and audio response for that Mode.

The other icons that can appear here are:

-  – This icon means that a Detect Mode has been modified but not yet saved.
-  – This icon means that one of your User Modes has been selected.

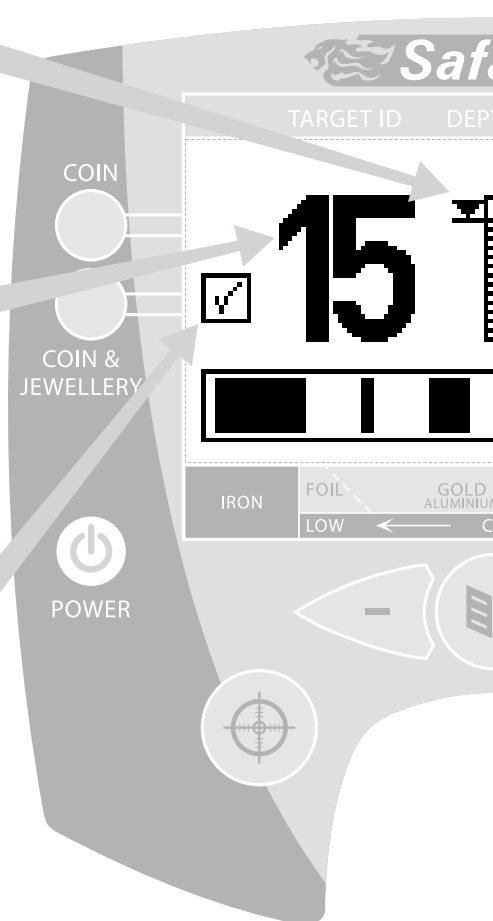

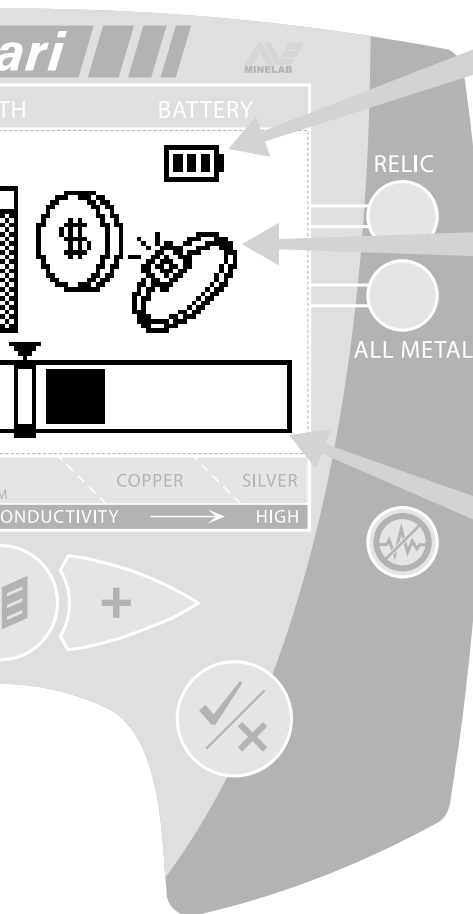

### Battery Power Icon

This shows the level of stored power in your battery. A fully charged battery shows the icon as fully shaded. As the power in the battery is used the shaded area depletes until a fully discharged battery is un-shaded.

### Target Icons

Safari will also indicate the likely target type located, using a select number of generic icons. At times the Detect Screen may display two icons at once, indicating that the characteristics of the target located are similar to that of a number of targets.

**Note:** Target icons only appear in the Coin and Coin & Jewellery Detect Modes.

### Graphic Identification Bar

Located across the base of the screen is a horizontal bar graph which serves a number of purposes. It shows you the Discrimination Pattern that has been set, as well as:

- Dark bars showing the areas of rejection. This means certain unwanted target types will be rejected (or ignored) by the detector.
- Light bars showing areas of acceptance. This means the detector will recognise, and indicate to you, when certain desirable targets are found.
- When a target is detected, a triangular cursor will flash three times above a cursor box, the location of which corresponds to the ID number shown in the Detect Screen.

## Sweeping the Coil

You will obtain the best performance when the coil is swept close and parallel to the ground at all times. This will increase detection depth and improve the response to small objects. Avoid excessive brushing of the coil on the ground. Though the coil assembly is rigid and durable, sudden jolts or bangs can cause random signals and inaccurate target IDs. Careful sweeping will ensure the detector performs to an optimum level at all times.





**CAUTION:** Incorrect coil sweeping can generate false signals or miss targets.

Practise sweeping the coil over the ground in a side-to-side motion while slowly walking forward at the end of each sweep. Slightly overlap the previous sweep to ensure full ground coverage. An average sweep speed is four seconds from left to right to left.

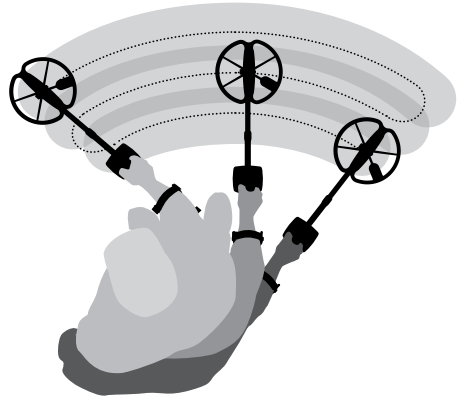

## Targets

Metal objects are referred to as targets. Targets are comprised of ferrous and nonferrous metals. Ferrous metals are those containing iron; such as steel, nails and some types of coins.

Nonferrous metals are those which are not magnetic, such as gold, silver, copper, bronze and aluminium.

You may wish to find a range of both ferrous and nonferrous targets.

### Examples of common targets:

- Desired high ferrous target – war relic
- Undesired high ferrous target – iron nail
- Desired nonferrous target – gold coin
- Undesired nonferrous target – pull-tab



Before attempting to recover real targets, it is important to understand how to interpret the audio and visual signals of the detector.

Gather a collection of different metal objects, e.g. various coins, gold and silver jewellery, a nail, pull-tab, brass button and aluminium foil.

Take the detector outdoors, away from known sources of EMI and metal objects.

Lay objects in a line, sufficiently spaced apart to allow the coil to pass between them, as shown below.

## Detector Sounds

Turn the detector On.

The detector may produce **False Signals** (Noise) when not over the ground or with the coil held motionless. These may not be target signals, but surrounding electromagnetic interference (EMI). You can minimise these False Signals by performing a **Noise Cancel** (p. 27), or by reducing the **Sensitivity** (p. 26) of the detector. It is generally better to try to reduce False Signals by adjusting Noise Cancel before resorting to reducing the Sensitivity.

The constant background 'hum' produced by the detector is called the **Threshold** (p. 27). Variations in the Threshold allow you to hear very small and deep targets. It is also used to help distinguish between desired and undesired targets.

Sweep the coil across the targets one at a time. Observe the LCD and listen to the sounds of the detector as it passes over each object. Although the LCD will give you detailed information about the target, it is important to pay attention to the difference in audio response between each of the objects.

***Note:** If you are getting signals from a visibly clear patch of ground, there could be buried metal objects. Try finding another area to practise.*



Nail



Pull-Tab



Foil

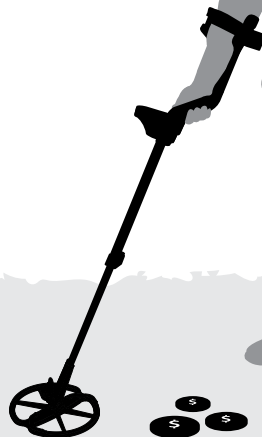

Coins



Jewellery



# A Simple Detecting Exercise

## Detector Sounds (cont)

The **Audio Response** is the sound produced by the detector when a target is detected and not 'rejected'. When using Coin and Coin & Jewellery Mode, a highly conductive target (e.g. a large silver coin) will generally produce a high-pitched tone and a low conductive target (e.g. foil) will generally produce a low-pitched tone. Large targets or targets close to the ground surface emit louder signals.

When a 'rejected' target is detected, the Threshold '**blanks**' (becomes silent), indicating that a target is located underneath the coil, but has been rejected by the **Discrimination Pattern** (p. 30). Blanking is a useful way of distinguishing between desired and undesired targets.

**Note:** As the coil passes over the nail, the Threshold 'hum' momentarily disappears (blanks).

Large objects close to the coil may **Overload** the detectors electronics. When this happens, Safari displays an Overload message and emits an Overload sound until the coil is moved away from the source of the overload.

Overloading is not harmful to the electronics of the detector.

It is important to understand the sounds produced when you make a valid or invalid button press. You will usually encounter these sounds while adjusting settings via the Main Menu.

**Tip:** When detecting do not wear steel-toed boots or shoes with metal eyelets. These can send conflicting signals to your detector.

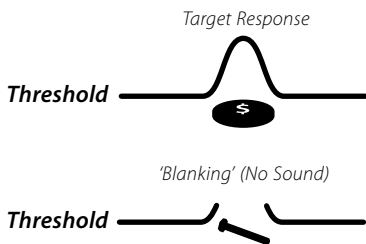



There are four factory preset Detect Modes and four Save Modes available for searching. Each Detect Mode is customized with the optimum settings, to allow you to find the types of objects described by the Detect Mode name.

The four Detect Modes are:

- Coin
- Coin & Jewellery
- Relic
- All Metal

In some locations, there may be a specific pattern to the type of targets found in the area. For example, an old house or building site may have areas where a certain junk is concentrated, or other areas where it is more likely that coins have been lost. On the beach, foil and modern coins are more plentiful in the dry sand, whereas less junk and more gold jewellery are located in the wet sand.

Due to the different types of targets you may expect in certain areas, you will often prefer a different Discrimination Pattern for each area. With Safari you have the choice to search in one of the factory preset Discrimination Patterns, or you can create and save your own patterns to suit the different areas you commonly search.

## Start – Up

On initial start-up (or after Factory Preset), your detector will default to the factory Coin Detect Mode.

To select a different factory preset Detect Mode, press and release the appropriate Mode button.

The icon next to the corresponding preset Mode , indicates that a factory preset Mode has been selected. The detector will apply the factory determined Discrimination Pattern and audio response for that Mode.

**Note:** *You cannot change Detect Modes while in Pinpoint mode.*



## Coin Mode

This Mode has a Discrimination Pattern that is best for ignoring a variety of junk targets, while still being able to detect most coins. One of the features of Safari is its ability to vary the tone on the target signal. In Coin Mode the Audio tone will vary according to the level of conductivity of the detected metal. For example, highly conductive metals like silver, gold and brass will produce a high pitch tone. Lower conductive items like foil, nickel, and low carat jewellery will produce a lower pitched tone.

The preset Discrimination reject settings for this Mode are -10 to +2 and +6 to +8.

**Use:** This mode is best used in high trash areas such as modern parks, sporting grounds, playgrounds and busy beaches. It will ignore a large percentage of foil and ferrous trash.

**Note:** *Some modern coins are produced with nickel or steel cores and should be considered in certain regional applications. These coins may not be detected in Coin Mode.*

## Coin & Jewellery Mode

This mode has a slightly reduced level of rejection in its Discrimination Pattern to enable you to locate coins, as well as gold jewellery. It allows some coins with a high ferrous content or low carat jewellery that may have been discriminated in Coin Mode to be detected, however, aluminium foil will also be detected. The Audio tone will vary depending on the conductivity of the target in the same fashion as Coin Mode.

The preset Discrimination reject settings for this mode are -10 to -1.

**Tip:** *Low tone = Low Conductivity content.  
High tone = High Conductivity content.*

**Use:** The most common use for this Mode is for those who are prepared to dig some foil and pull tabs to find all gold jewellery; ideal for beaches, old parks, abandoned house sites, camps, etc.



## Relic Mode

The Relic Mode has an even lower level of rejection in its Discrimination Pattern as many rare and valuable relics can have very low conductivity, and/or ferrous content. The Audio tone in Relic Mode is different to Coin and Coin & Jewellery Detect Modes. It uses the ferrous (iron) content to determine the pitch of the Audio tone.

**Note:** Depending on which Mode you select, a beep and icon will appear briefly which will indicate which mode the audio response is in. This is shown as:



**Conductive  
Audio Response**

or



**Ferrous  
Audio Response**

In Relic Mode, a target with a high ferrous content will produce a low tone and a target with a low ferrous content will produce a high tone.

The preset reject Discrimination settings for this Mode are -10 to -3. Because of this, beach hunters who specifically target gold jewellery may also prefer to use Relic Mode.

In Relic Mode, the Detect Screen Target Icons are not shown. Operators using this mode are more likely to interpret signals using the Target ID Numbers and audio response only.

## All Metal Mode

All Metal Mode is similar to Relic Mode, the difference being that no Discrimination is used in All Metal Mode.

All Metal Mode's audio response also uses the object's ferrous characteristics for producing the Audio tones, like in Relic Mode.

**Tip:** This is the best Mode to use when a maximum target recovery rate is important, like in some competition hunts or when you are looking for any and all metals.



# Pinpoint

Pinpoint assists you in locating the exact position of a detected target.

Normally, Safari is a 'motion' detector; it must be moving over a target in order to detect it. When Pinpoint is activated, Safari will operate as a non-motion detector; it will produce a constant audio response while the coil is held stationary over a target. Pinpoint instructs the detector to temporarily disengage Discrimination Patterns. Therefore, all targets will be detected if underneath the coil.

When Pinpoint is activated, the target icons on the detect screen will be replaced by a locator bar graph, as shown below.



In Pinpoint, Safari will produce a clear 'beep' as the search coil passes directly over the target. The locator bar graph in the Detect Screen will also fill out on the screen as the coil passes directly over the target.

### Pinpointing the Target:

- 1 Once the approximate target location is known, move the coil to one side of that location and press Pinpoint.
- 2 Sweep the coil slowly over the target location.

**Note:** Keep the coil parallel to the ground while Pinpointing.

- 3 Taking note of the response, reduce the span of each successive pass of the coil until you are confident of the location of the target. Make a mental note of the position, or mark a line on the soil with your shoe or a digging tool.
- 4 Move to one side so that you can pass the coil over the target at right angles to your initial direction.
- 5 Repeating the above steps in the new direction will give an exact location to dig.

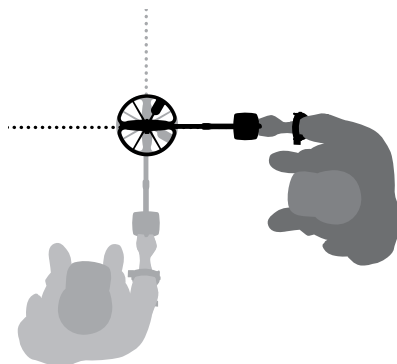

### Tips:

- When in Pinpoint, Safari does not discriminate between metal targets.
- Always press the Pinpoint button again when returning to search (do not search in Pinpoint mode)
- After Pinpointing, and laying the detector down to dig the target, it is common for the detector to give an intermittent signal. Switching out of Pinpoint when digging, then returning to Pinpoint again if the location of the target needs to be confirmed can overcome this.
- Do not press the Pinpoint button when directly over a target as this may cause a constant signal.

The Safari has the following user adjustable settings:

-  – Sensitivity
-  – Threshold
-  – Noise Cancel
-  – Target Volume
-  – Contrast
-  – Trash Density

All the settings above are adjusted via the Menu screen by following these steps:

- 1 Press the Menu button to access the Menu screen.

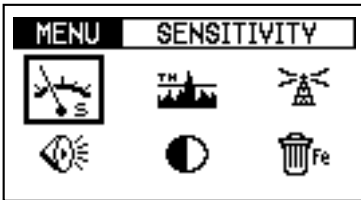

- 2 To adjust one of these settings, use the – or + arrow buttons until the desired selection is highlighted. To avoid pressing the – or + buttons numerous times, you can press and hold in the button and the selection will move smoothly, then release the button when you've reached your desired selection.
- 3 Press the Menu button again, to activate the highlighted selection. This will take you to a screen specific to that setting.

- 4 Use the – or + arrow buttons to adjust the setting to the desired value.
- 5 Press the Menu button again to apply the setting, and return to the Menu screen to select another control.

**Note:** When you have finished making changes to the Menu settings [this may be just one or all six], you can press the Accept/Reject button, or any of the four Mode buttons, to return to the Detect Screen and start detecting.



## Sensitivity

The Sensitivity control is adjustable to set the best level of Sensitivity for the environment being detected. The factory preset setting is in Auto, and this will self adjust to suit the conditions you are detecting in. You can also lock the Sensitivity to suit a particular area by manually selecting a level between 0 and 20.

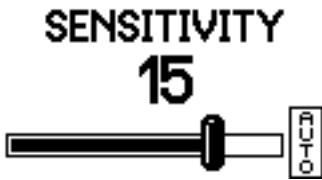

A manual Sensitivity setting can be used in areas with blanket/constant soil mineralisation, such as beaches or modern parks. However, Auto Sensitivity is the preferred setting when detecting areas with variable soil conditions, until you become experienced with your detector.

**Tip:** *If you prefer to search in Manual and some ground noise persists, reduce the Sensitivity level to the point where false signals cease.*

**Tip:** *If your detector is unstable and producing erratic noises it is recommended to always perform a Noise Cancel prior to reducing the Sensitivity of the detector!*



## Target Volume

The Target Volume control is used to adjust the maximum volume of the target signal — not Safari's overall volume. The Target Volume range available is 0 to 20, and the preset level is 20.



Target Volume can be used to prevent signals from large and shallow items producing very loud signals that are uncomfortable to your ears. This should be adjusted to suit your individual hearing.

**Note:** *The Target Volume control sets the Target Volume only and does not affect the detector's Sensitivity or power.*



## Threshold

The Threshold controls the audible level of sound during detecting, or the “background hum”. Most operators find that detecting with a very low but still audible Threshold is preferred. A lower level may mask responses to smaller targets and the higher levels will make targets difficult to hear. The level preset by Minelab is 12.



The Threshold range is from 0 to 40.

**Tip:** The use of headphones will normally allow the Threshold to be reduced.



## Noise Cancel

In many locations where you will be detecting there maybe electromagnetic interference (EMI) which can make your detector unstable. This instability will manifest as erratic false signals from the detector, which makes detecting actual targets very difficult. To eliminate the effects of EMI you will need to perform a Noise Cancel by either selecting it in the menu or by simply pressing the Noise Cancel button on the control panel (p. 15).

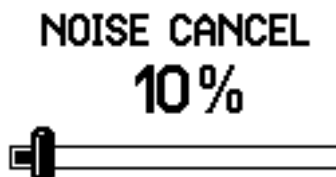

Whilst holding the detector still, press the Noise Cancel button on the control panel. Safari will automatically scan and select the quietest operating frequency and should run smoothly once complete. This process takes approximately 20 seconds.



**Important:** While performing a Noise Cancel it is important to keep the detector's coil motionless, and also ensure that no metallic objects are moved in close proximity to the detector's coil.

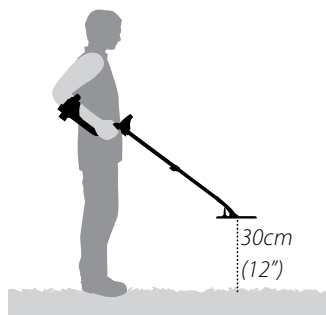

As EMI can vary over time, you may need to repeat this process over the course of a detecting session.



## Contrast

The contrast of the LCD can be adjusted using the Contrast control.



By adjusting the Contrast, relative to the current light conditions, you may make the information on the LCD easier to see.



## Trash Density

The Trash Density control will enable you to optimise your Safari for detecting in locations with differing amounts of trash content in the soil.

## TRASH DENSITY



**High** is the factory preset setting, suitable for most common locations where coins and relics are found, and also areas with variable ground mineralisation. The High setting detects targets at a faster rate, so in areas with a lot of trash, particularly if close together, the High setting is more likely to detect the presence of a “good” target in amongst a number of rejected or trash targets.

In High setting, when rejecting certain targets using the Accept/Reject function, one or two more target ID segments/ numbers may need to be rejected in order to fully ignore the target. However, if searching for a specific target, a much narrower “Accept” pattern is possible, allowing you to ignore a greater percentage of unwanted trash or other targets.

High is the preferred setting when detecting in heavily mineralised or variable ground.



In High setting, Safari's signal response works faster to pick out good targets in between all the trash but requires a wider Discrimination Pattern to reject a specific target. This is easily demonstrated by attempting to use the Accept/Reject function in High setting:

- Sweep the coil over a junk object that you would like to eliminate, and attempt to reject it by pressing Accept/Reject.
- Now pass the coil over the target again and repeat the process
- The Safari will continue to find different metals in the target and it will show different IDs.
- It may require you to reject a number of ID numbers before a specific target is fully rejected.

High setting can be used with a slightly faster sweep speed, so is suitable for use during competition hunts, or in areas where speed of ground coverage is important.

**Low** is a speciality setting which should only be used in very clean ground such as beaches or some inland locations such as open forests and large fields. In these locations, Low provides you with the most precise target ID and allows you to create a narrow Discrimination Pattern to reject troublesome trash targets.

The Low Trash Density setting also has a slightly better depth capability in most soil conditions, but it is not recommended in areas where targets may be close together.

The performance characteristics of the two modes is summarized in the table below:

<i>Trash Density Performance Characteristics</i>				
<i>Setting</i>		<i>Accept/Reject Functionality</i>	<i>Detection in average soils, and low trash sites</i>	<i>Detection in mineralised soils, and high trash sites</i>
<i>Trash Density</i>	<b>Low</b>	Very good	Very good	Average – may miss detection of nonferrous targets
	<b>High</b>	Average	Very good	Good



# Discrimination

## Discrimination (Accept/Reject) Scale

When a target is detected, an ID number appears on the left hand side of the screen and a bar and cursor appear in the Discrimination scale along the bottom of the screen in the Graphic Identification Bar. In Coin and Coin & Jewellery Modes a Target Icon also appears on the right hand side of the screen.

The location of the target cursor corresponds to the discrimination rating or ID number of the object.

When an object is detected, the target cursor will momentarily flash.

On the Graphic Identification Bar the black area represents rejected target IDs and the clear area represents accepted target IDs.



## Interpreting target responses

The Target ID Range has 51 numbers from -10 to +40.

Ferrous (Iron) objects will have IDs in -10 to -1 range.

Nonferrous (non-iron) objects will have IDs in the 0 to +40 range.

Objects with higher Conductivity will have higher IDs.

## To Modify the Discrimination Pattern:

The Discrimination Pattern of a factory preset mode can be modified and saved as a personal setting, so that your own preferred Discrimination Pattern is ready for use any time you wish.

The  icon will be displayed on the screen to indicate that a mode has been temporarily modified.

There are three methods of modifying the Discrimination Pattern.

### Method 1 –

#### To reject a specific target/object:

- 1 Wave the coil over the object. The detector will move the cursor to indicate the object's position on the scale, and the target's ID number will appear on the screen.
- 2 Press the Accept/Reject button to reject the object's ID.
- 3 Wave the coil over the target and check that it is being rejected. If it still produces a response, reject its new ID by pressing Accept/Reject a second time.



**Method 2 –****To reject a specific Target ID number:**

- 1 In the Detect screen use – and + buttons to select the ID you want to modify. The cursor and the Target ID numbers will indicate the selected ID.
- 2 Press the Accept/Reject button to either accept or reject that ID. You will notice the band on the discrimination scale will become shaded if rejected or clear if accepted. The Accept/Reject button will toggle between accepting and rejecting targets.

**Method 3 –****To accept or reject a large range of Target IDs:**

- 1 Start from either the first or last number of the ID band you wish to select.
- 2 Push and hold both the Accept/Reject button, and the – or + button until the selected area is achieved. You will note that the cursor box on the Graphic Identification Bar will be shaded when the Accept/Reject button is in Reject mode and clear when in the Accept mode.

**Tip:** The Accept/Reject button is very effective when in the Low Trash Density setting. The High setting enhances the detectors ability to pick out good targets in high concentrations of Iron, and as a result the Accept/Reject function is not as accurate. (See p. 28 for more information on Trash Density)

Once the Discrimination Pattern has been modified, the  icon will appear next to the Mode button to show that the Detect Mode has been modified. These changes to the Discrimination Pattern will be lost if you select a different Detect Mode. The modified Discrimination Pattern can be saved as a User Mode by following the steps in *To Create and Save a User Mode* (p. 32).



# Discrimination

## To Create and Save a User Mode:

- 1 Select the factory preset Detect Mode you want to alter.
- 2 Modify the Discrimination Pattern as per *To modify the Discrimination Pattern* on p. 30.
- 3 Press and hold (approx. 3 seconds), the appropriate Mode button until the Saved message is displayed on the screen as shown below:

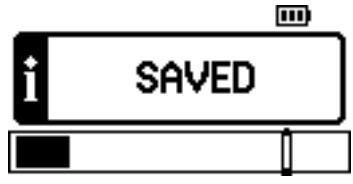

**Note:** Any time a different Mode button is selected, a small sound (loudspeaker) icon is displayed next to the battery level icon. It will stay on for ten seconds and will show if the mode is using Conductive or Ferrous sounds. This is shown as:

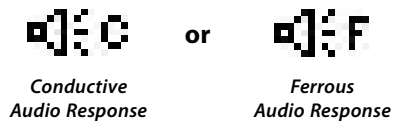

- 4 When the Mode is saved, the  icon will appear next to the Mode button that was pressed. You can save your personal preset Mode in any of the four preset locations.

Once a User Mode is saved, simply press the Mode button to revert to the factory preset Mode  or press it again to return to your personal saved Mode. This allows you to easily toggle between the two, to compare responses on various targets.



## Detector

<b>Transmission</b>	Full Band Spectrum (FBS). Simultaneous Frequency Transmission ranging from 1.5–100kHz
<b>Coil</b>	11" Double D (waterproof)
<b>Audio Output</b>	Internal Speaker or Headphones
<b>Liquid Crystal Display (LCD)</b>	64 x 128 pixels (40mm x 70mm)
<b>Length</b>	Collapsed: 1050mm (41") Extended: 1370mm (54")
<b>Detector Weight</b>	1.65kg (3.63lbs) (excluding batteries and headphones)
<b>Coil Weight (Including Skidplate)</b>	522g (1.15lbs) +/- 10g (0.02lbs)
<b>Operating Temperature Range</b>	0°C to 50°C (32°F to 122°F)
<b>Operating Humidity Range</b>	Up to 90% Relative Humidity at 40°C (104°F)
<b>Storage Temperature Range</b>	-30°C to 80°C (-22°F to 176°F)

## Battery (Accessory Item Only)

<b>Type</b>	Nickel Metal Hydride (NiMH)
<b>Output Voltage</b>	9.6V
<b>Capacity</b>	1600mAh or 1800mAh
<b>Input (Charge)</b>	12V @ 100mA
<b>Charge Time</b>	1600mAh = 18 hours, 1800mAh = 22 hours
<b>Weight</b>	255g (0.56lbs)
<b>Operating Temperature</b>	0 °C to 50 °C (32 °F to 122 °F)
<b>Storage Temperature</b>	-30 °C to 80 °C (-22 °F to 176 °F)
<b>Battery Charge Temperature Range</b>	0 °C to 45 °C (32 °F to 113 °F)



<i>All Settings</i>			
<i>Setting Title</i>	<i>Range</i>	<i>Factory Preset</i>	<i>My Preferred</i>
<i>Detect Modes</i>			
* Detect Mode	Coin, Coin & Jewellery, Relic or All Metal	Coin Mode	
<i>Discrimination</i>			
Coin	-10 to +40	-10 to +2 and +6 to +8	
Coin & Jewellery	-10 to +40	-10 to -1	
Relic	-10 to +40	-10 to -3	
All Metal	-10 to +40	Open	
<i>Menu Settings</i>			
Sensitivity	Auto or 0-20	Auto	
Threshold	0-40	12	
Noise Cancel	-	Automatic	
Target Volume	0-20	20	
Contrast	1-20	10	
Trash Density	Low or High	High	

\* – Each factory preset Detect Mode has a slot for saving your own User Mode (p. 29).

To start the detector in the 'Factory Preset' mode, (recommended in your first few outings) press and hold the Power button (approximately five seconds) until the Factory Preset message is displayed on the screen.



A trowel, knife or small spade are good tools for recovering targets.

Once a target has been located, clear the surface of loose material and check again for a signal. If there is no signal then the target is amongst the surface material. In this case, search the surface material until the target is located. If the target is still in the ground, Pinpoint its position.

Using a sharp tool, cut a neat portion of grass or soil and place it on a plastic sheet. This prevents the material being scattered around and allows the hole to be refilled quickly. Dig carefully to avoid defacing or devaluing the object.

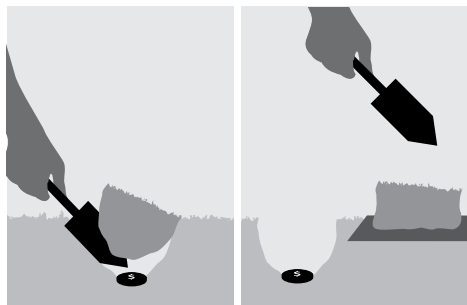

Check the hole for the target. If it is not in the hole, place the detector on the ground with the coil flat, pick up a handful of soil and pass it over the coil. Be sure not to wear rings, bracelets or a watch which will produce a signal. Repeat this procedure until the target is located.

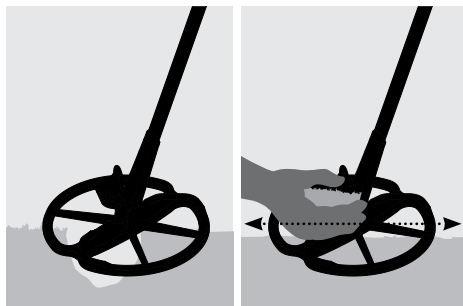

Ensure that no other targets remain, then refill the hole. All soil and portions of grass on the plastic sheet should be returned to the hole as neatly as possible. Step lightly on the soil to compact it.

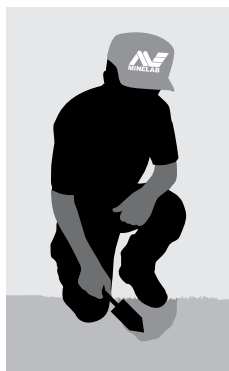

Leaving holes, or a scarred area, may result in action being taken to prevent the use of metal detectors. Please ensure that you remove all rubbish. The aim is to leave the area of ground exactly as you found it.



A question most new detectorists ask is, “where do I find treasure”? There are actually lots of areas in which you can search. It is best if you research where people have been in the past, what type of objects they might have had with them, and hopefully lost. You can also go to areas people still use on a daily basis such as the beach or parks, and search for modern coins and jewellery.

Here is a list of some of the more productive places to search:

- Your own backyard
- The beach
- Showgrounds & racecourses
- Picnic areas
- Battlefields
- Camping grounds
- Swimming holes
- Parks and playgrounds
- Ghost towns & ancient town sites
- Old homes & public buildings
- Old gold mining sites
- Sports grounds
- School yards and ovals
- Around jetties and piers
- Drive-in theatres

There is a chance of finding buried treasure, such as coins, relics and jewellery, anywhere that people have been in the past. In order to maximise your return, select sites that have the most potential.

For example, a small park that is just used as a walkway between houses is likely to be littered with junk with very few valuable targets in it. Whereas a larger old park with picnic tables, playgrounds, etc. would have had thousands of people sitting around, playing sports, laying on blankets etc. and you can almost be certain that there will be some goodies waiting for your metal detector.

**Note:** *Be sure to obtain the land owners permission before searching on private property, and always check local regulations. Your local Minelab dealer may be able to assist.*

Always refill your holes. If you leave the ground exactly as you found it, you shouldn't have any problem detecting the same area in the future.



Safari is a high-quality electronic instrument, finely engineered and packaged in a durable housing. Taking proper care of your detector is mostly common-sense.



**CAUTION – Please note the following:**

- Do not leave the battery pack in the Safari handle when the detector is not in use for extended periods. Damage caused by leaking batteries could be severe and would void the warranty through user negligence.
- Do not leave the detector in excessive cold or heat for longer than necessary. Covering it when not in use will help protect it. Avoid leaving it in a closed car boot or in a car sitting in sunlight. A full-length detector carry bag is available to protect the detector when in transit.
- The control box has been designed to resist moisture, but is not water-proof. Minelab advises protecting the control box in extreme conditions. The control box should not be dropped into water. A control box cover will give protection against dust, dirt and light rain.
- Never allow the detector to come into contact with gasoline or other petroleum-based liquids.
- Keep the detector clean and dry and avoid getting sand and grit into the shafts or fastenings (e.g. yoke bolt and camlocks). Do not use solvents to clean the detector. Use a damp cloth with mild soap detergent.
- Ensure the coil cable is in good condition and not subject to undue stress.
- Flat or faulty batteries cause many detector problems. Ensure that only quality alkaline batteries are used, and that they are replaced when you hear the warning signal through the headphones or speaker.
- Do not dispose of the optional NiMH battery pack in fire (contact local authorities for disposal/recycling). Do not attempt to disassemble or short circuit the battery pack.
- Take precautions when transporting or storing the detector. Although the detector is constructed from the highest quality materials and has undergone rigorous durability tests, the display screen could be prone to scratching or serious damage if not treated with due care.



<b><i>Detector does not start at all</i></b>	<ul style="list-style-type: none"><li>- Check the condition of the batteries and battery connections.</li><li>- Ensure battery pack is fully inserted, and it has clicked into place.</li><li>- If using alkaline batteries, check whether they have been loaded in the right polarity.</li></ul>
<b><i>Detector starts, but it switches off by itself</i></b>	<ul style="list-style-type: none"><li>- Check the condition of the batteries. If necessary, try starting with batteries known to be in good condition.</li><li>- Detector may be too hot. Allow detector to cool down in a shaded area.</li><li>- Try starting the detector with search coil disconnected. If the detector starts normally, check the state of the coil cable. If it is damaged, replace the coil. Otherwise return detector for repairs.</li></ul>
<b><i>No sound</i></b>	<ul style="list-style-type: none"><li>- Unplug the headphones. If there is sound in the speaker but not in the headphones, check the headphones and their connection.</li><li>- Check the Target Volume setting (a setting of 0 is silent).</li><li>- If there is no sound in the speaker or the headphones but the detector appears to work normally otherwise, return the detector for repairs.</li></ul>
<b><i>Erratic noises</i></b>	<ul style="list-style-type: none"><li>- Press the Noise Cancel button.</li><li>- Reduce the Sensitivity.</li><li>- Change the orientation of the coil to the vertical plane and rotate to see if there is a position where the noise is loudest. If this is the case, it means that there is a source of interference nearby which must be avoided.</li><li>- Check battery charge and battery connections.</li><li>- Ensure coil connector is tightened firmly.</li><li>- Check headphones and their connection.</li><li>- Check for sand or grit between coil cover and coil.</li></ul>
<b><i>No target response</i></b>	<ul style="list-style-type: none"><li>- Ensure the detector is turned On.</li><li>- Check headphones and their connection.</li><li>- Check coil connection.</li><li>- Check discrimination level. No signal will be given if target is within black area of the Graphic Identification Bar.</li></ul>





There is a two-year parts and labour warranty for the electronic control box of Safari. The coil has a one year parts and labour warranty. Refer to the supplier or Minelab for service, either in or out of warranty. The Minelab warranty does not cover damage caused by accident, misuse, neglect, alteration, modifications, or unauthorised service.

For specific details of the Minelab warranty, please refer to Safari's 'Product Warranty Card'.

This warranty is not transferable, nor is it valid unless the enclosed warranty registration card is returned to Minelab or your Minelab dealer within 14 days of the original purchase.

## Repairs

In the unfortunate circumstance that the detector needs to be returned to Minelab for service, please fill out the Minelab Service Repair Form (or a photocopy of the same) and enclose it with the detector.

Please supply as much detail about the fault as possible. This will assist our service engineers to rectify the problem quickly and efficiently.

## Parts and Accessories available for Safari:

- 8" FBS Coil
- 8" FBS Coil Skidplate
- 11" Coil Skidplate
- Sealed 1800mAh Rechargeable NiMH SlimPack
- Sealed 1600mAh Rechargeable NiMH SlimPack
- 12V Car Charger
- Koss UR-30 Headphones
- Tall Man Lower Shaft 610mm (24")
- Control Box Cover
- Detector Carry Bag
- Minelab Tool & Trash Bag

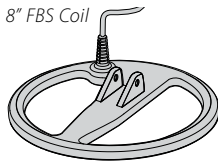

8" FBS Coil

NiMH SlimPack

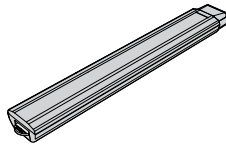

12V Car Charger

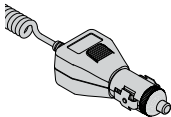

Koss UR-30 Headphones

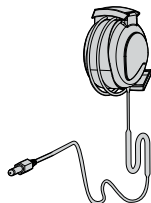

If you would like to purchase any accessories for your Safari or any other Minelab product, please feel free to contact us directly or via your local Authorised Minelab dealer.



**Owners Name** .....

**Address** .....

**Telephone** Day ( ) Home ( ) .....

**Fax ( )** .....

**Email** .....

**Todays Date** .....

**Detector / Model** .....

**Serial Number** .....

**Purchased From** .....

**Purchase Date** .....

**Faulty Part(s)** .....

.....

**Description of Fault**

Please explain how we can replicate the problem in order to fix your detector.

.....

.....

.....

.....

.....

.....

.....

.....

.....

.....

cut out or photocopy





## The World Leader in Metal Sensing Technology

*From our origins in 1985, Minelab have specialised in advanced electronic technologies. Our competitive advantage was created almost immediately with a highly competent and innovative Research and Development team, inspired by the genius of Mr Bruce Candy.*

*This commitment to innovation has enabled us to successfully market feature packed Consumer coin and treasure detectors enjoyed by hobbyists worldwide as well as high quality gold detectors used by both professionals and amateurs. Minelab's advanced technology is also incorporated in detection equipment designed for military and humanitarian de-mining projects throughout the world.*

*Today Minelab has manufacturing, distribution and customer service operations in Australia, Europe and the United States, and is an ISO 9001 Quality Endorsed Company. ISO 9001 is a worldwide quality standard certification that ensures the highest level of product quality for our customers.*

© 2008 Minelab Electronics Pty Ltd

This document contains proprietary information which is protected by copyright. Apart from any use as permitted under the Copyright Act 1968, no part may be reproduced by any process without written permission from Minelab Electronics Pty Ltd, 118 Hayward Avenue, Torrensville, SA 5031, Australia.

WARNING. This document contains Minelab Electronics Pty Ltd rights, technical data or restricted rights data, or both. Patents and trademarks apply. Safari, Serious Detecting and Minelab are all trademarks of Minelab Electronics Pty Ltd.



### Working for a Cleaner, Greener Future

For Consumers within the European Union: Do not dispose of this equipment in general household waste.

The crossed wheeled bin symbol on this equipment indicates this unit should not be disposed of in general household waste, but recycled in compliance with local government regulations and environmental requirements.

Please dispose of this equipment via a recycling service or centre, or by returning the unit to the respective Minelab outlet as appropriate for your unit. This will enable the equipment to be disposed of in an environmentally safe manner.

Disposal of unwanted electronic equipment in land filled waste may contribute to adverse long term environmental effect due to the leaching of contaminating and toxic substances contained within some electronic equipment.

### THIS DEVICE COMPLIES WITH PART 15 OF THE FCC RULES

Operation is subject to the following two conditions: (1) this device may not cause harmful interference, and (2) this device must accept any interference received, including interference that may cause undesired operation.

#### Disclaimer:

The Minelab metal detector discussed in this instruction manual has been expressly designed and manufactured as a quality hobbyist metal detector and is recommended for use in coin, treasure and general metal detection in nonhazardous environments. This metal detector has not been designed for use as a mine detector or as a live munitions detection tool.

### Please note:

Since there may be a variety of options available for this detector, equipment may vary according to the Model or items ordered with your detector. Certain descriptions and illustrations may also differ (in this manual) from the exact Model that you purchased. In addition, Minelab reserves the right to respond to ongoing technical progress by introducing changes in design, equipment and technical features at any time.

## **Minelab Electronics Pty Ltd**

PO Box 537, Torrensville Plaza  
Adelaide, South Australia, 5031

### **Australia**

Tel: +61 (0) 8 8238 0888

Fax: +61 (0) 8 8238 0890

Email: [minelab@minelab.com.au](mailto:minelab@minelab.com.au)



## **Minelab International Ltd**

Laragh, Bandon  
Co. Cork

### **Ireland**

Tel: +353 (0)23 885 2101

Fax: +353 (0)23 885 2106

Email: [minelab@minelab.ie](mailto:minelab@minelab.ie)



## **Minelab USA Inc**

871 Grier Drive, Suite B1  
Las Vegas, Nevada, 89119

### **USA**

Tel: +1 702 891 8809

Fax: +1 702 891 8810

Email: [info@minelabusa.com](mailto:info@minelabusa.com)

